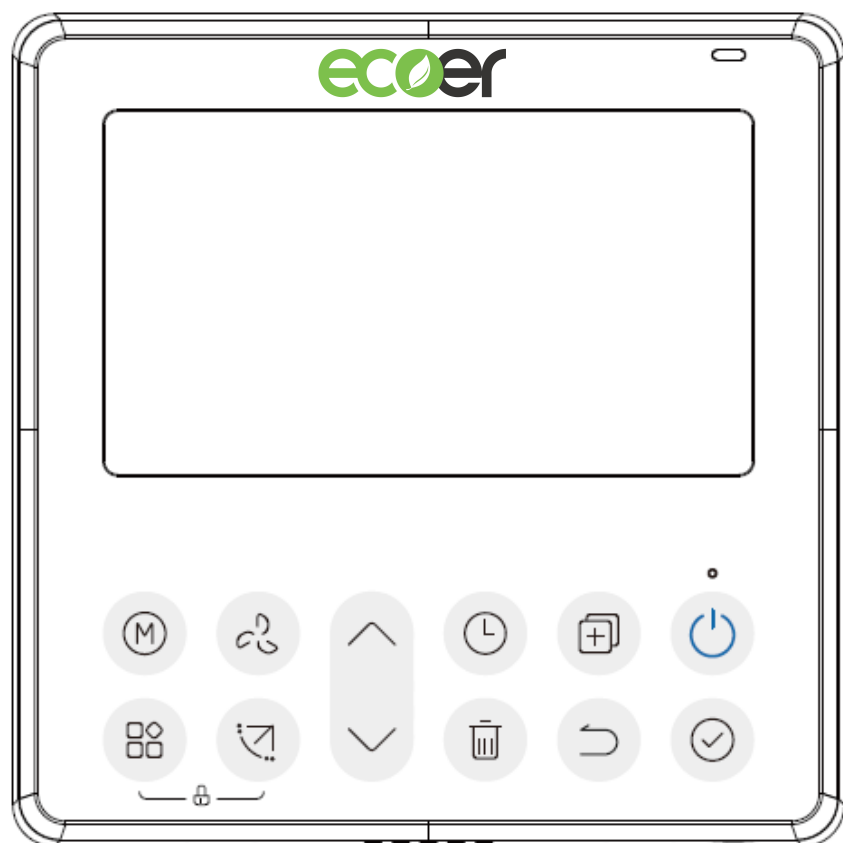




ECT01 Wi-Fi Programmable Thermostat

Install and User Guide



Appearance of the product may vary.

1. Safety precaution	2
2. Installation accessory	3
3. Installation method	5
4. Specification	13
5. Feature and function of the wired controller	14
6. Name on the LCD of the wired controller	15
7. Name of button on the wired controller	16
8. Preparatory operation	17
9. Operation	18
10. Timer functions	28
11. Weekly Timer 1	31
12. Weekly Timer 2	37
13. Fault alarm handing	44
14. Technical indication and requirement	44
15. Queries and settings	45
16. Wireless control connection	50

This manual gives detailed description of the precautions that should be brought to your attention during operation.

In order to ensure correct service of the wired controller please read this manual carefully before using the unit.

For convenience of future reference, keep this manual after reading it.

All the pictures in this manual are for explanation purpose only. There may be slightly different from the wired remote controller you purchased (depend on model). The actual shape shall prevail.

1. Safety Precaution

WARNING

- Please entrust the distributor or professionals to install the unit.
- Installation by other persons may lead to imperfect installation, electric shock or fire.
- Adhere to this installation manual.
- Improper installation may lead to electric shock or fire.
- Reinstallation must be performed by professionals.

Do not uninstall the unit randomly.

Random uninstalling may lead to abnormal operation, heating or fire of the air condition.

NOTE

- Do not install the unit in a place vulnerable to leakage of flammable gases. Once flammable gases are leaked and left around the wire controller, fire may occur.
- Do not operate with wet hands or let water enter the wire controller. Otherwise, electric shock may occur.
- The wiring should adapt to the wire controller current. Otherwise, electric leakage or heating may occur and result in fire.

NOTE

- The specified cables shall be applied in the wiring. No external force may be applied to the terminal. Otherwise, wire cut and heating may occur and result in fire.

2. Installation accessory

Select the installation location

Don't install at the place where cover with heavy oil, vapor or sulfureted gas, otherwise, this product would be deformed that would lead to system malfunction.

Preparation before installation

2.1 Please confirm that all the following parts you have been supply.

No.	Name	Qty.	Remarks
1	Wire controller	1	_____
2	Installation and owner's manual	1	_____
3	Screws	3	M3.9*25 (For Mounting on the Wall)
4	Wall plugs	3	For Mounting on the Wall
5	Screws	2	M4X25 (For Mounting on switch box)
6	Plastic screw bars	2	For fixing on switch box
7	Battery	1	CR2032 3V
8	The connective wires group	1	Standard signal wires group
9	Screw	1	M4X8(For Mounting the connective wire group)

2. 2 Prepare the following assemblies on the site.

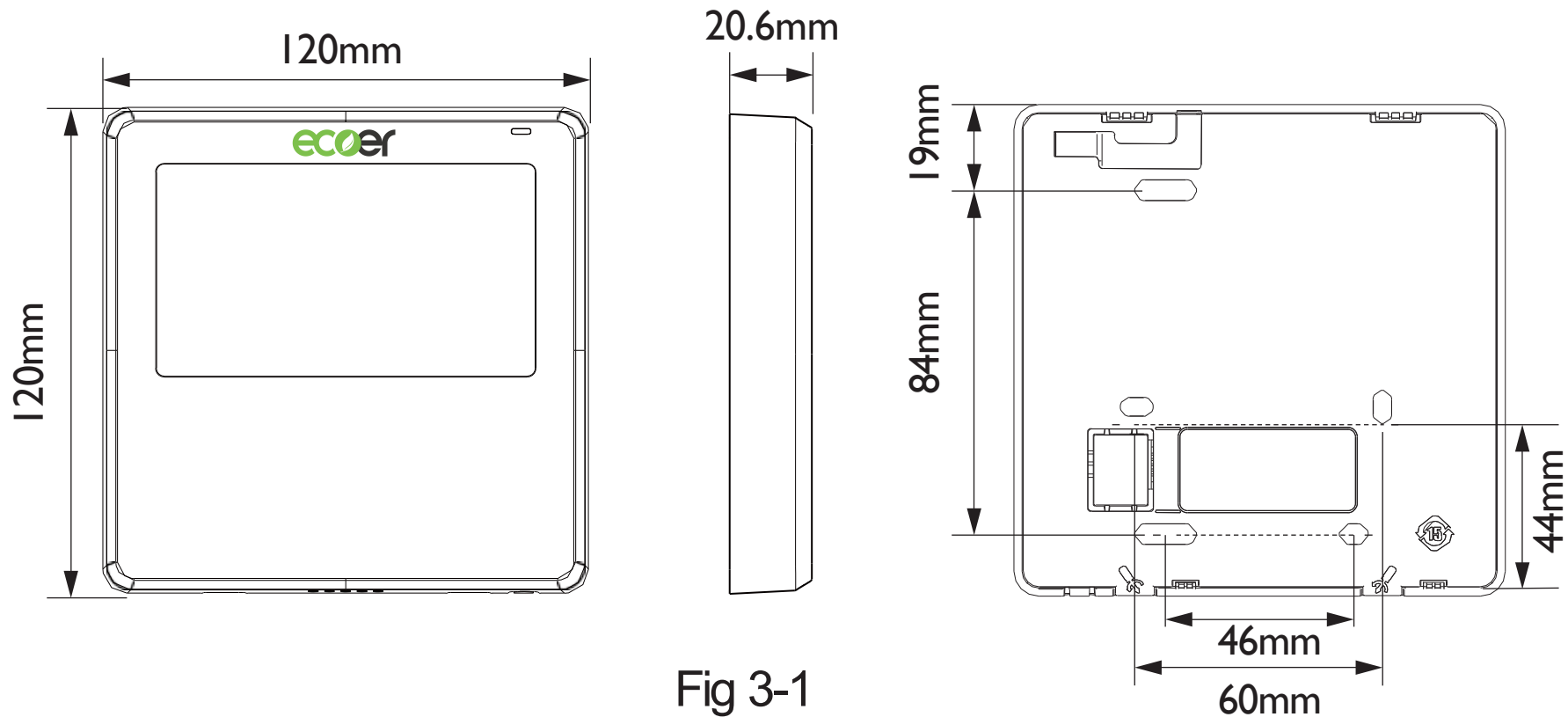
No.	Name	Qty.(embedded into wall)	Specification (only for reference)	Remarks
1	Switch box	1	_____	_____
2	Wiring Tube(Insulating Sleeve and Tightening Screw)	1	_____	_____

Precaution of installing the wire controller

1. This manual provides the installation method of wired controller. Please refer to the wiring diagram of this installation manual to connect the wire controller with indoor unit.
2. The wired controller works in low voltage loop circuit. Forbid to directly contact the cable of high voltage above, like 115V,220V,380V, and don't wire this kind of wire in the said loop; wiring clearance between configured tubes should be at the range of 300~500mm or above.
3. The Shielded wire of the wired controller must be grounded firmly.
4. Upon finish the wire controller connection, do not employed tram egger to detect the insulation.

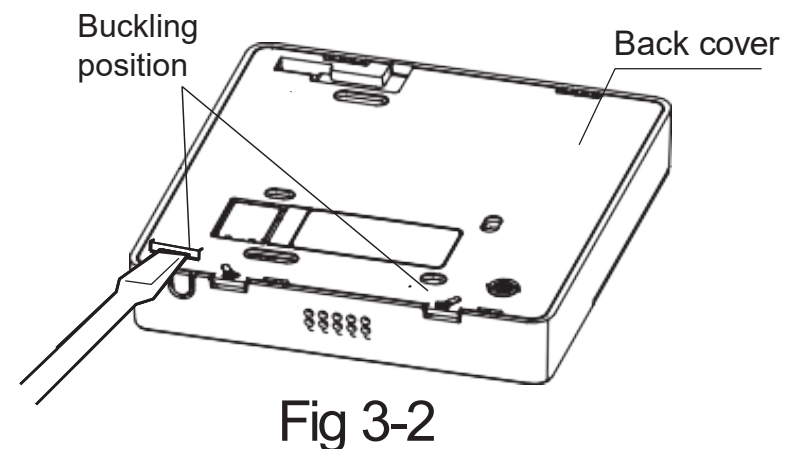
3. Installation method

3.1 Wired remote controller structural dimensions



3.2 Remove the upper part of wired controller

- Insert a slot screwdriver into the slots in the lower part of the wired controller (2 places), and remove the upper part of the wire controller. (Fig.3-2)



NOTE : Do not pry up and down, you can only rotate the screwdriver.

NOTE : The PCB is mounted in the upper part of the wired controller. Be careful not to damage the board with the slot screwdriver.

3.3 Fasten the back plate of the wired

- For exposed mounting, fasten the back plate on the wall with the 3 screws (ST3.9*25) and plugs. (Fig.3-3)

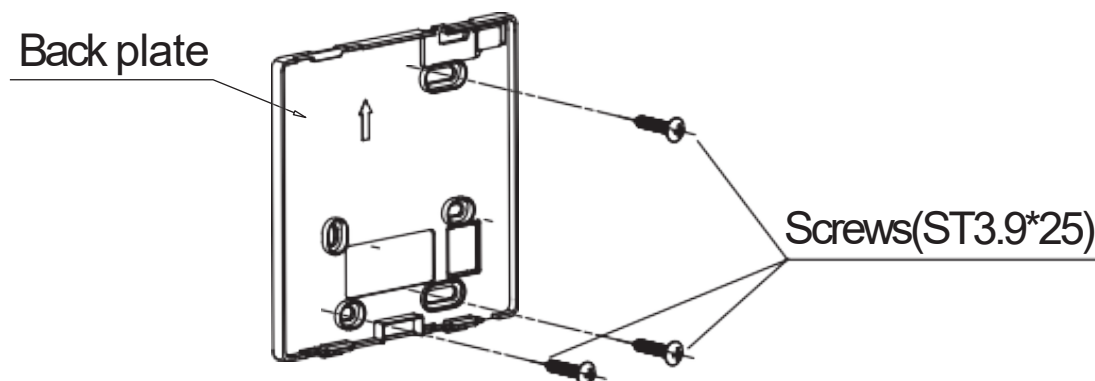


Fig 3-3

- Use two M4X25 screws to install the back cover on the 86 switch box, and use one ST3.9*25 screw to fix to the wall.

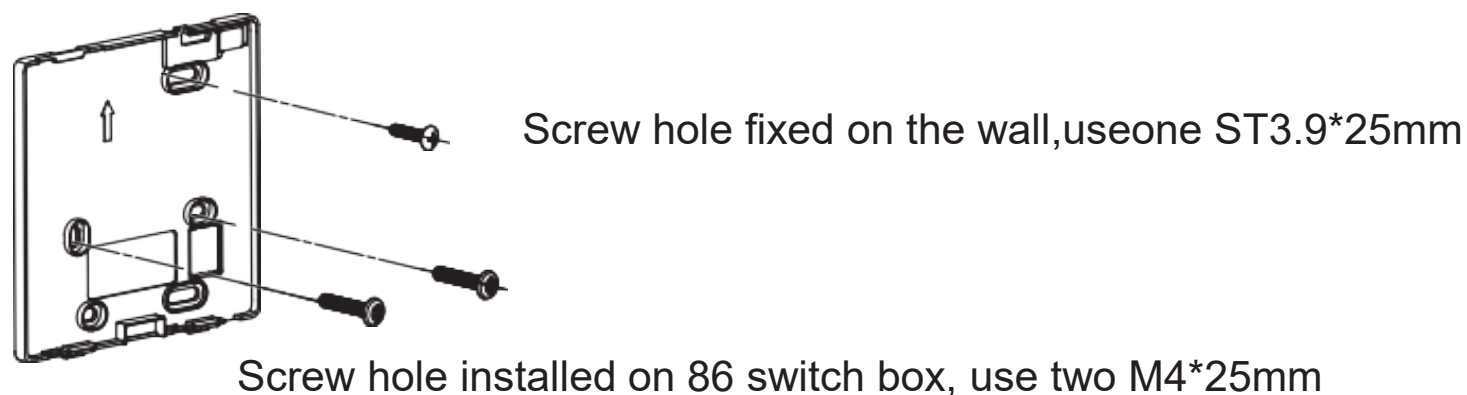


Fig 3-4

NOTE : Put on a flat surface. Be careful not to distort the back plate of the wire controller by overtightening the mounting screws.

3.4 Battery installation

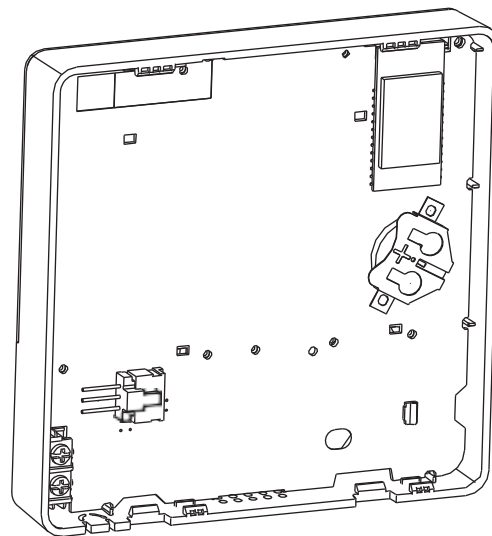


Fig 3-5

- Put the battery into the installation site and make sure the positive side of the battery is in accordance with the positive side of installation site. (See Fig.3-5)
- Please set the time corrected on the first time operation. Batteries in the wire controller can time under power failure which ensure the time keep right. When the power restores, if the time displayed is not correct, it means the battery is dead and replace the battery.

3.5 Wire with the indoor unit

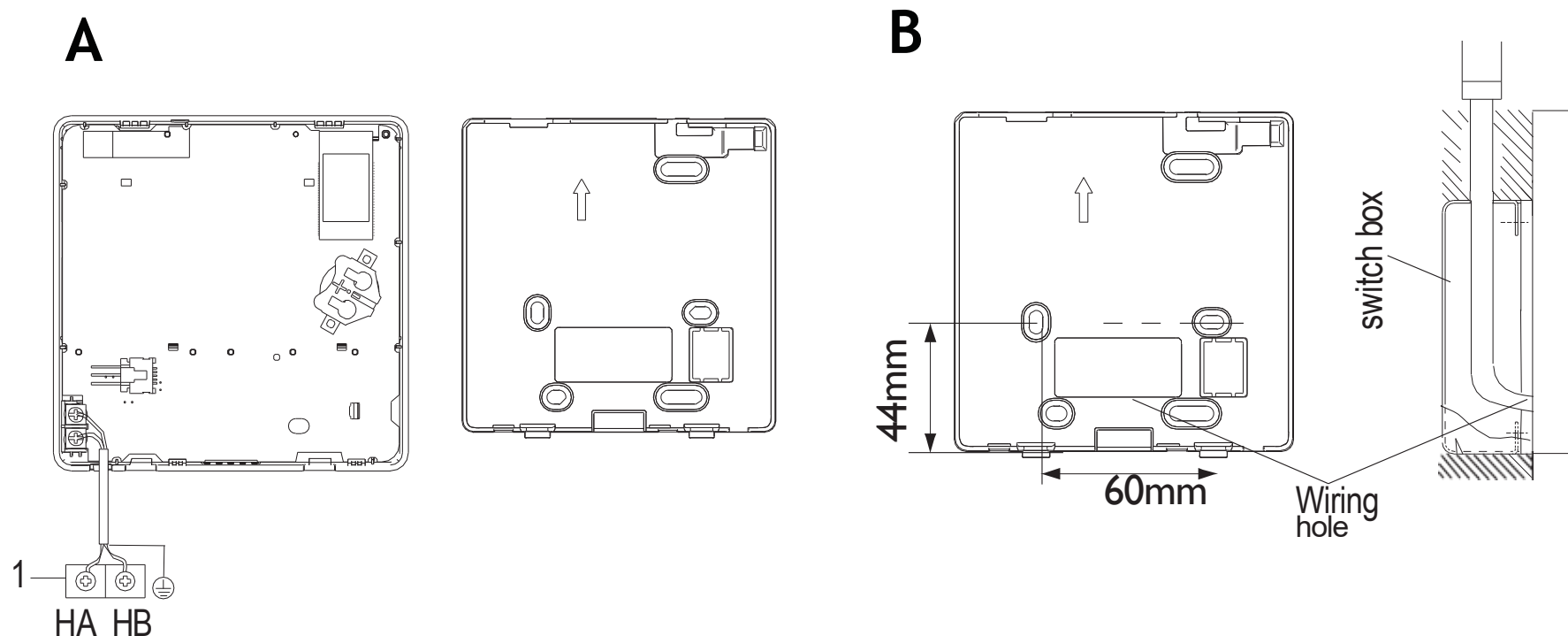


Fig 3-6

Indoor unit

Notch the part for the wiring to pass through with nippers, etc.

Connect the terminals on the wired controller (HA ,HB), and the terminals of the indoor unit (HA ,HB). (HA and HB do not have polarity.)

NOTE :

- DO NOT allow water to enter the wired control. Use the trap and putty to seal the wires.
- Connecting wires must be fixed reliably and cannot be pulled.
- These signal wires are equipped on site.

For some units, the wired controller connects to the unit HA and HB ports through the HA and HB ports. There is no polarity between HA and HB. See Fig. 3-7

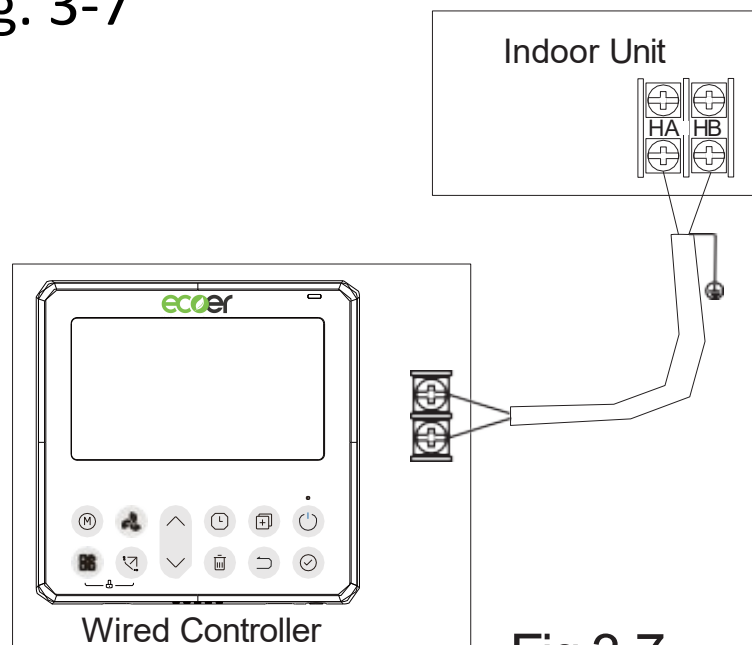


Fig.3-7

For some units, one wired controller can support multiple units (a maximum of 16 units). In this case, the wired controller and unit need to be connected to the HA and HB ports at the same time. In group control, there will be no error displayed on the wired controller. See Fig. 3-8

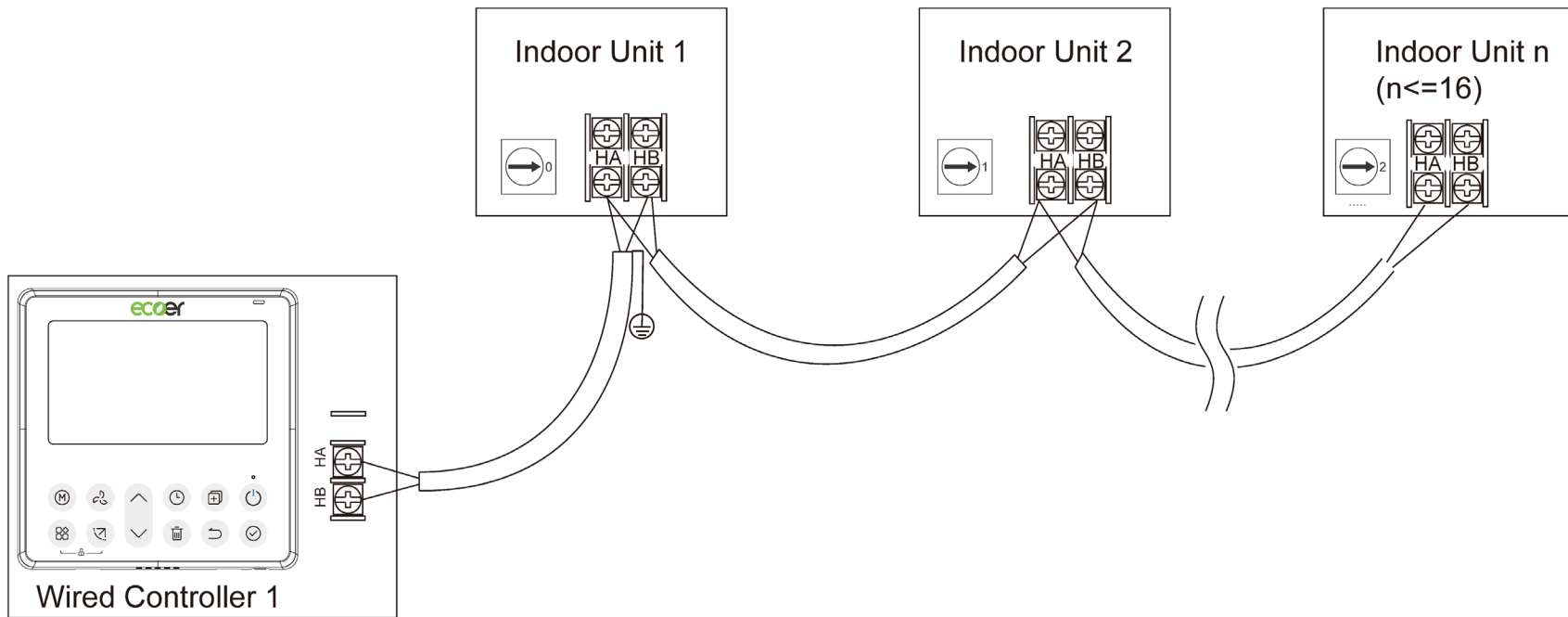


Fig.3-8

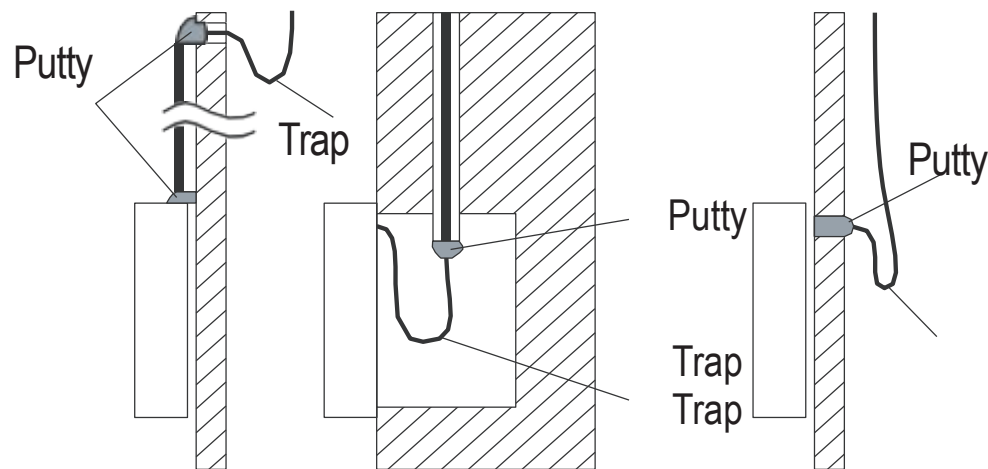


Fig 3-9

3.6 Warranty Registration via ESS Pro App

With the wired controller, Ecoer Inc. provides an easy way for dealers to help their customers complete registration via Ecoer Smart Service (ESS) Pro App in just minutes. Then dealers can monitor units' health and do troubleshooting quickly. Alternatively, homeowner / dealer / contractor/ builder can register at www.ecoer.com. But it will not allow the dealer to monitor the system.

Log in Ecoer Smart Service (ESS) Pro **App >Files>Installation** to get the newest guide.

Search **ECOER** on App Store or Google Play. Download or update **Ecoer Smart Service Pro App**.

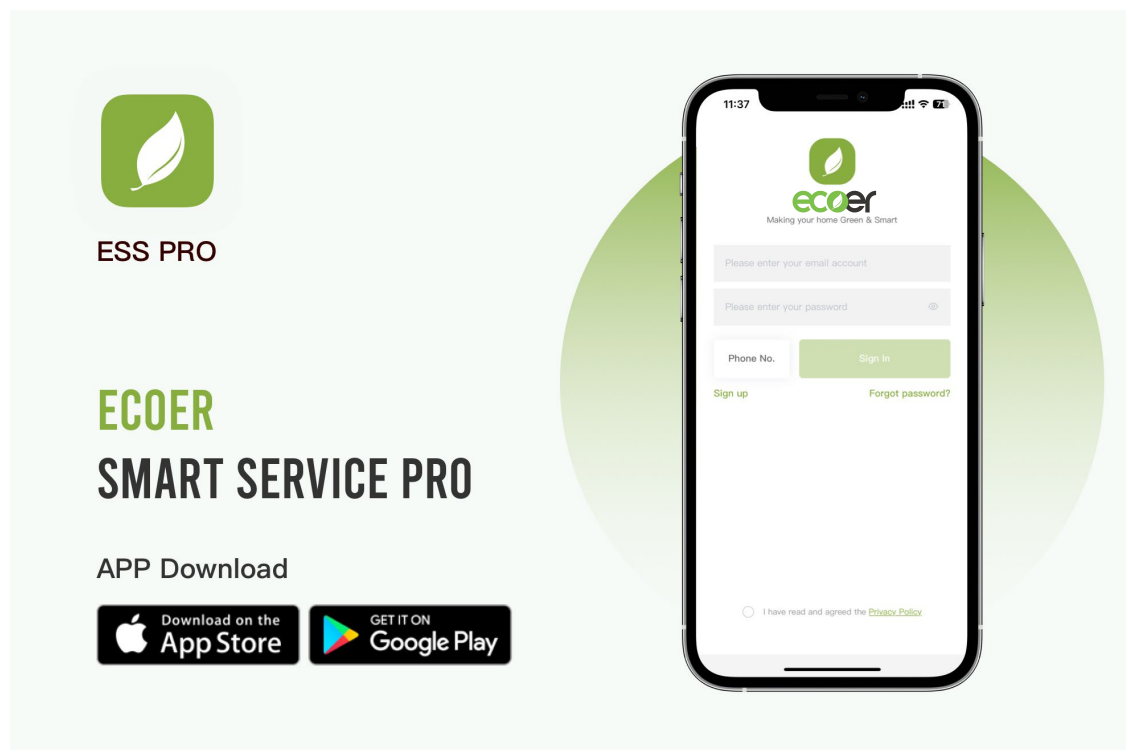


Fig.3-10

Steps of warranty registration *

1. Create an ecoer account
2. Add Unit (Register a new Wired Controller/AC/HP)
 - Sign an agreement with homeowner
 - Scan/Input serial numbers to submit

*Log in **ESS Pro App >Files >Installation** to get the newest guide.

3.7 Reattach the upper part of the wired controller

- After adjusting the upper case and then buckle the upper case; avoid clamping the wiring during installation. (Fig 3-11)

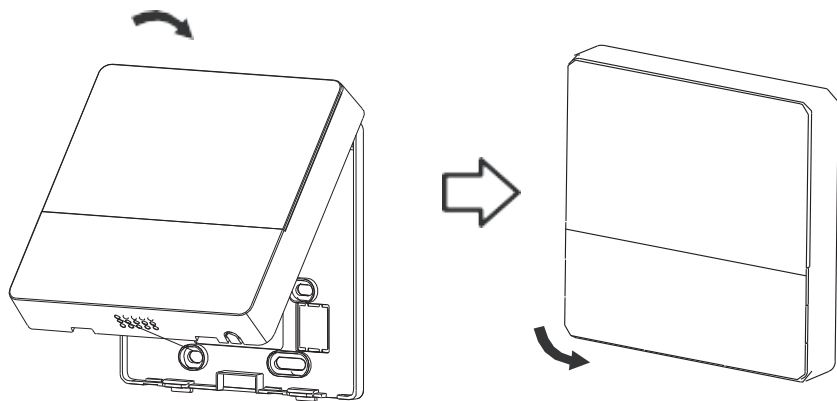


Fig 3-11

All the pictures in this manual are for explanation purpose only. Your wire controller may be slightly different .The actual shape shall prevail.

4. Specification

Input voltage Ambient	12V
temperature	0~43°C(32~110°F)
Ambient humidity	RH40%~RH90%

Wiring specifications

NOTE: Suggested to use the connective wire of 6 meters length.

5. Feature and function of the wired controller



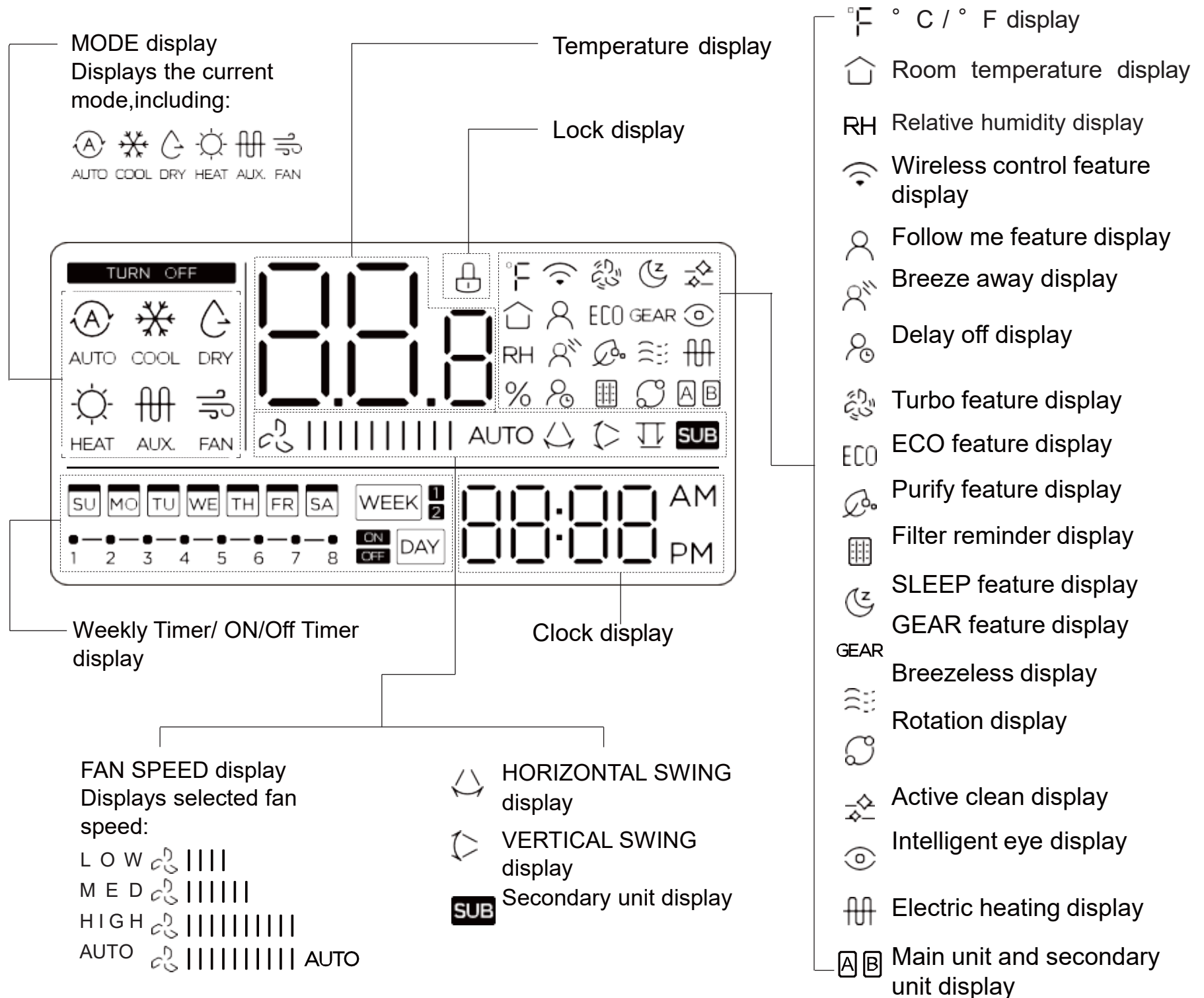
Feature:

- LCD display.
- Malfunction code display: it can display the error code, helpful for service.
- 4-way wire layout design, no raised part at backside, more convenient to place the wires and install the device.
- Room temperature display.
- Weekly Timer.

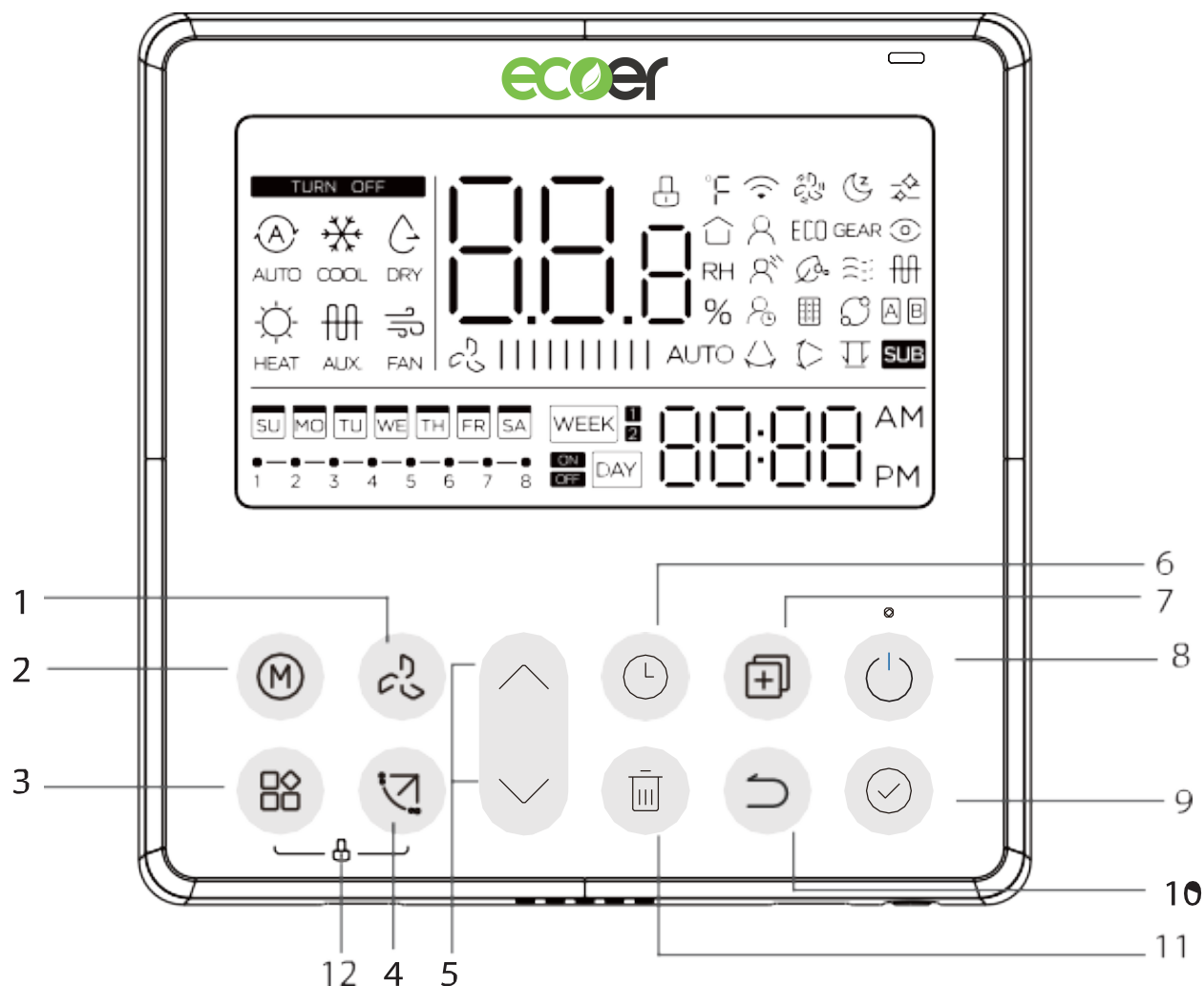
Function:

- Mode: Choose Auto-Cool-Dry-Heat-Fan
- Fan speed: Auto/Low/Med/High speed
- Swing(on some models)
- Timer ON/OFF
- Temp setting
- Weekly timer
- Follow me
- Turbo
- 24-hour System
- 12-hour System
- Auto-restart
- Individual louver control (on some models)
- Automatic airflow test
- Rotation & Back-up
- Dual Control
- Group Control
- Child Lock
- LCD display
- Clock

6. Name on the LCD of the wired controller



7. Name of button on the wired controller



1. FAN SPEED button

2. MODE button

3. FUNC. button

4. SWING button

5. ADJUST button

6. TIMER button

7. COPY button

8. POWER button

9. CONFIRM button

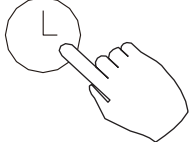
10. BACK button




11. DAY OFF/DELAY button

12. CHILD LOCK button


8. Preparatory operation




Set the current day and time

- 1  Press the Timer button for 2 seconds or more. The timer display will flash.

- 2  Press the button “” or “” to set the date. The selected date will flash.




- 3  The date setting is finished and the time setting is prepared after pressing Timer button or CONFIRM button or there is no pressing button in 10 seconds.

- 4  Press the button “” or “” to set the current time. Press repeatedly to adjust the current time in 1-minute

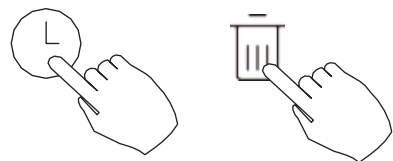


ex.Monday 11:20



increments. Press and hold to adjust the current time continuous.

- 5  The setting is done after pressing CONFIRM button or there is no pressing button in 10 seconds.

6

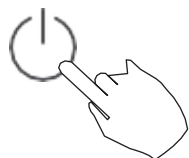


Time scale selection

Press the buttons “” and “” for 2 seconds will alternate the clock time display between the 12h & 24h scale.

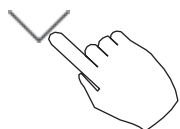
9. Operation

To start/stop operation



Press the Power button.

8 degree heating function (on some models)



When the heating mode is 10°C(50°F)/16°C(60°F)/17°C (62°F) / 20°C(68°F) , press the down button twice within 1 second to turn on the 8 ° heating function, and press the Power, Mode, adjust , Fan speed, Timer, and Swing button to cancel the 8° heating function.

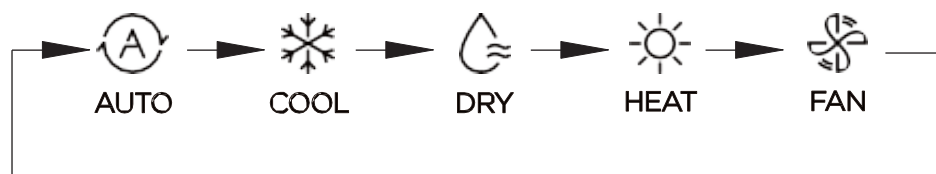
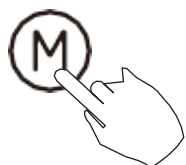
NOTE :

For some models, the 8° heating function can only be set by remote control, you can not choose this function by wired controller.

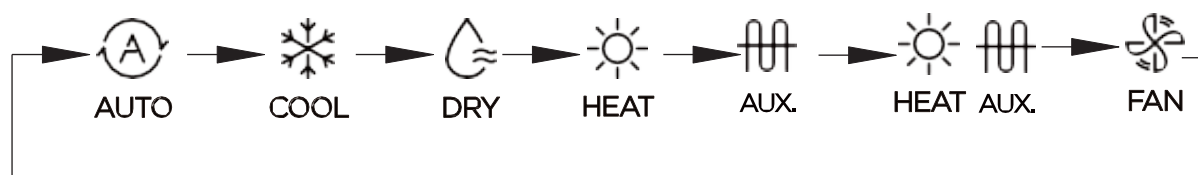
To set the operation mode



Operation mode setting(Heat mode is invalid for cool only type unit)

Press this button to select the operation mode:



If the indoor unit has Electric heating(Emergent heating) feature, press this button to select the operation mode:



- When the mode is selected as emergency heating (or electric heating) mode,  is displayed, the fan speed is Auto. The Sleep, 8-degree heating, Turbo, and Rotation functions are not available in emergency heating mode.
- When the mode is selected as heating & electric heating mode,  is displayed, and the Turbo and Rotation functions are disable.

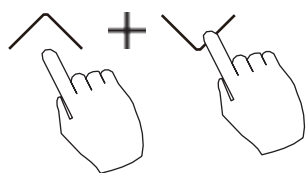
Room temperature setting

 Lower



Press the button “” or “” to set the room temperature. Indoor Setting Temperature Range :

 Raise

10/16/17~30°C(50/60/62~86°F) or 20~28°C(68~82°F).
(Model dependent)



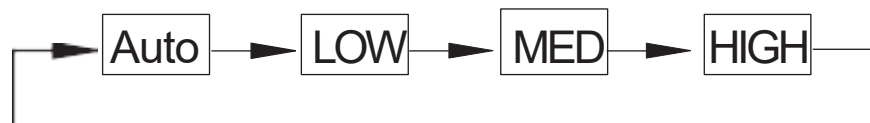
°C & °F scale selection (on some models)

Press the buttons “” and “” for 3 seconds will alternate the temperature display between the °C & °F scale.

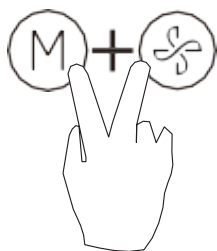
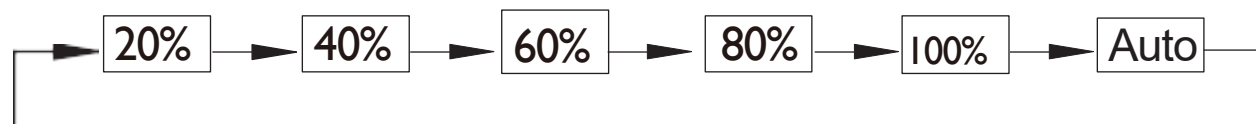
Fan speed setting





Press the Fan speed button to set the fan speed. (This button is unavailable under Auto or Dry mode)

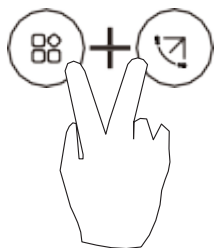




When stepless speed regulation is supported, press the fan speed key to cycle through:




Press the buttons  and  together for 3 seconds to turn on or turn off the keypad tone.

Child lock function



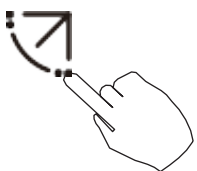
Press the buttons “” and “” for 3 seconds to activate the child lock function and lock all buttons on the wire controller. You can't press the button to operate and receive the remote control signal after the child lock is activate.

Press these two buttons again for 3 seconds to deactivate the child lock function.

When the child lock function is activated, the “” mark appears.


Swing function(For the units with horizontal & vertical swing features only)

1 Up-Down swing



Press the SWING button to start up-down swing function. The “” mark appears. Press it again to stop.


2 Left-Right swing

Press the Swing button for 2 seconds to start Left-Right swing function. The “” mark appears. Press it for 2 seconds again to stop.




Swing function(For the units without vertical swing function)



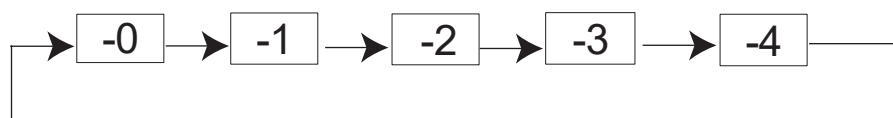
- Use Swing button to adjust the Up-down airflow direction and start the auto swing function.

1. Each time you press this button, the louver swings an angle of 6 degrees. Press this button until the desired direction reaches.
 2. If press and hold the button for 2 seconds, the auto swing is activated. The “” mark appears. Press it again to stop. (some units)
- For the units with four Up-Down louvers, it can be operated individually.

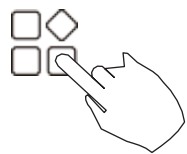


1. Press the Swing button to activate the Up-Down adjusting louver function.
The  mark will flash.(Not applicable to all the models)
2. Pressing the button “” or “” can select the movement of four louvers. Each time you push the button, the louver will be selected in a sequence as:

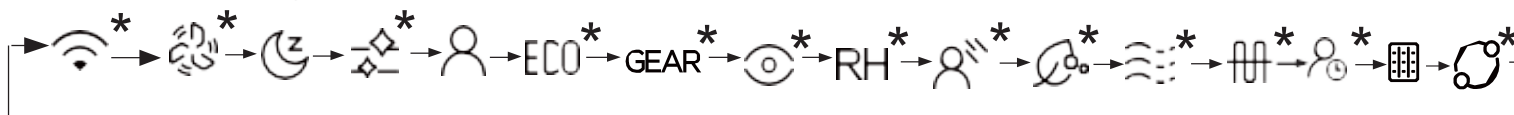
( means the four louvers move at the same time.)



3. And then use Swing button to adjust the Up-Down airflow direction of the selected louver.



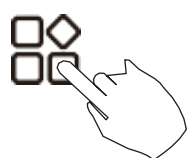
Press the FUNC. button to scroll through operation functions as followings:




[*]: Model dependent. If the indoor unit has no this function, it will not display.

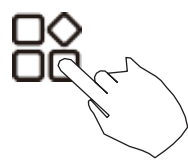
The select function icon will flash, then press the Confirm button to confirm the setting.


Turbo function (on some models)



Under COOL/HEAT mode, press the FUNC. button to activate the turbo function. Press the button again to deactivate the turbo function. When the turbo function is activated, the “” mark appears.

PTC function (on some models)



In heating operation, for the units with electric heating feature, press this button to activate electric heating mode. When the PTC function is activated, the “” mark appears.

NOTE: The electric auxiliary heating function of the AHU model is switched by the MODE button, and the FUNC. button is a turbo function.

Follow me function indicator

Press the FUNC. button to select whether the room temperature is detected at the indoor unit or the wire controller.

Intelligent eye display

1. This function is valid in any mode of power-on state.
2. When the indoor unit sending wire controller has the smart eye function, press the function key to select the smart eye icon, press the OK key to turn on the smart eye, and light up the smart eye icon at the same time; when the smart eye is turned off, the smart eye icon goes out.
3. Shutdown, switch mode, turn on self-cleaning, turn on 8-degree heating function will automatically cancel the smart eye function.

Filter reset function

After the indoor unit sends the wire controller filter usage time, the filter cleaning prompt icon lights up, press the function key to select the filter cleaning prompt icon, and press the OK key to reset the filter screen time. The filter cleaning reminder icon goes out.

Humidity setting function


1. When the indoor unit sending wire controller has dual control function of temperature and humidity, in dehumidification mode, press the function key to select the RH icon, press the confirm key to enter the humidity control mode, the RH icon flashes, press the up and down keys to adjust the humidity, the setting range is OFF->35%~85%, adjusted with 5% humidity. Exit humidity adjustment state after 5 seconds of inactivity.
2. After entering the humidity control mode, press the up and down keys to adjust the set temperature and display the set temperature for 5 seconds, and then restore the set humidity display.
3. After switching the mode, exit the humidity control mode.

GEAR function

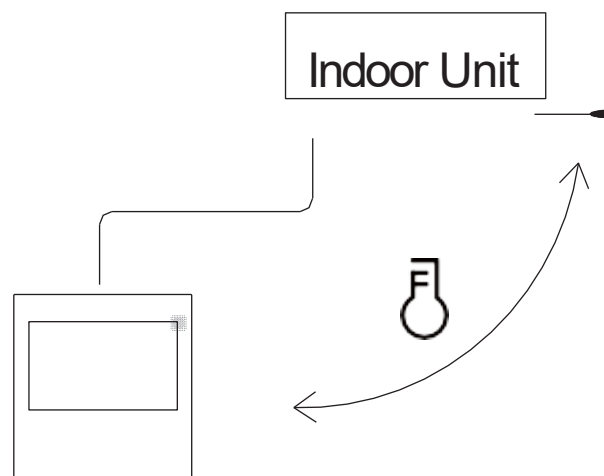
1. When the indoor unit sending wire controller has the GEAR function, in the boot cooling mode, press the function key to select the GEAR icon, press the confirm key to enter the GEAR control mode, and first display the current GEAR status.

50%→75%→OFF can be switched by the up and down keys within 5 seconds. After 5 seconds, the set temperature will be displayed, press the up and down keys to adjust the set temperature.

Turn off, switch to mode or turn on sleep, ECO, strong, self-cleaning functions to cancel the GEAR function.

When the follow me function  indicator appears, the room temperature is detected by the wire controller.

Press the button again to cancel the follow me function.



Rotation & Back-up indication

When there are two units, press the button to select the rotating function, and press “Confirm” to turn on or off the rotating function.

1. Press “Confirm” to set the rotating time, then press the button “ \wedge ” or “ \vee ” to set time. Setting time Range :1~99h,the default time is 10 hours.
2. Step 2 set high temperature co-open temperature -- or 26~32 degrees -- that is, this function is invalid. When the ambient temperature is 26~32 degrees, when the ambient temperature is greater than or equal to the set temperature, the two machines will run 24 degrees at the same time in the COOL mode.
3. Step 3 set the low-temperature co-open temperature -- or 5-15 degrees -- that is, this function is invalid. When the ambient temperature is 5-15 degrees, when the ambient temperature is lower than the set temperature, the two units will run at the same time for 24 degrees to make the heating mode.
4. Step 4: set which machine will run first. Select A or B.
5. After this function is turned on, as long as the air conditioner is running at the setting hour, it will automatically turn on another air conditioner and turn off the current air conditioner. Press the POWER button to switch to another one immediately. A or B icons flicker to indicate the corresponding air conditioning failure. Automatically switch to another machine when running time is reached or machine failure occurs.

10. Timer functions



WEEKLY timer

Use this timer function to set operating times for each day of the week.



On timer

Use this timer function to start air conditioner operation.

The timer operates and air conditioner operation starts after the time has passed.



Off timer

Use this timer function to stop air conditioner operation.

The timer operates and air conditioner operation stops after the time has passed.

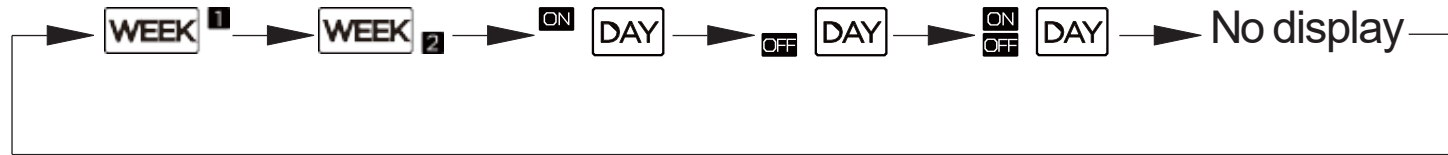


On and Off timer

Use this timer function to start and stop air conditioner operation. The timer operates and air conditioner operation starts and stops after the time has passed.

To set the On or Off TIMER

1  Press the Timer button to select the **ON DAY** or **OFF DAY**




2  Press the Confirm button and the Timer display is flashing.

3   

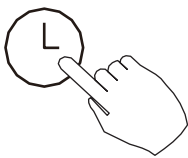


ex. Off timer set at 18:00


Press the button “” or “” to set the time.

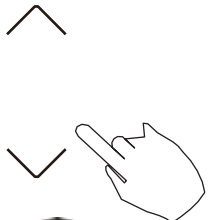

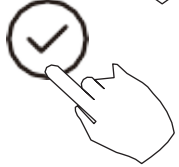
After the time is set, the timer will start or stop automatically.

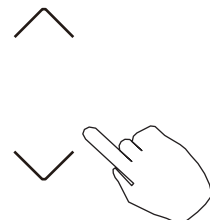
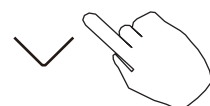
4  Press the Confirm button again to finish the settings.


To set the On and Off TIMER

- 1  Press the Timer button to select the   .

- 2  Press the Confirm button and the Clock display is flashing.

- 3 

 Press the button " ^ " or " v " to set the time of On timer, and then press the Confirm button to confirm the setting.

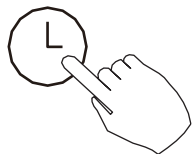
- 4 
 Press the button " ^ " or " v " to set the time of Off timer

- 5  Press the Confirm button to finish the settings.

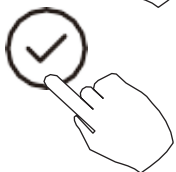
NOTE : The secondary wired controller cannot set the timer.

11. Weekly Timer 1

1 Weekly timer setting



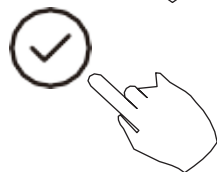
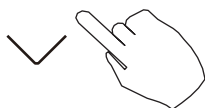
Press the Timer button to select the **WEEK** and then press the Confirm button to confirm.



2 Day of the week setting



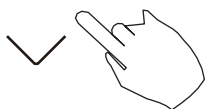
Press the button “ \wedge ” or “ \vee ” to select the day of the week and then press the Confirm button to confirm the setting.



3 ON timer setting of timer setting 1



Press the button “ \wedge ” or “ \vee ” to set the time of On timer and then press the Confirm button to confirm the setting.



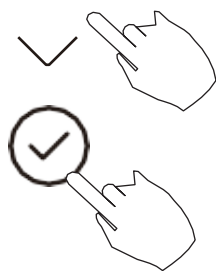


ex. Tuesday time scale 1

Up to 4 timer settings can be saved for each day of the week. It is convenient if the WEEKLY TIMER is set according to the user's life style.

4 Off timer setting of timer setting 1

Press the button “ \wedge ” or “ \vee ” to set the time of Off timer and then press the Confirm button to confirm the setting.



ex. Tuesday time scale 1

5 Different timer settings can be setted by repeating step 3 to 4.

6 Other days in one week can be setted by repeating step 2 to 5.

NOTE : The weekly timer setting can be returned to the previous step by pressing Back button. The time of timer setting can be delete by pressing Day off button The current setting will be restored and withdrawn the weekly timer setting automatically when there is no operation for 30 seconds.

WEEKLY timer operation

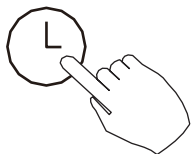
To activate WEEKLY TIMER operation

Press the Timer button while **WEEK**¹ is displayed on the LCD.

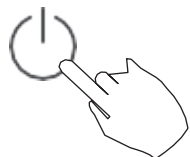


To deactivate WEEKLY TIMER operation

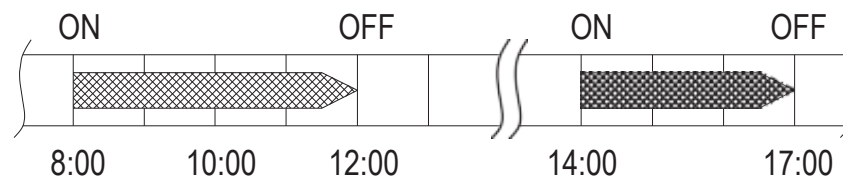
Press the Timer button while **WEEK**¹ is disappear from the LCD.



To turn off the air conditioner during the weekly timer



1. If press the Power button once and quickly , the air conditioner will turn off temporarily. And the air conditioner will turn on automatically until the time of On timer.

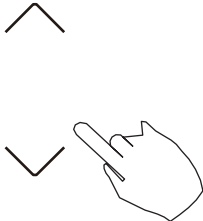


ex. If press the POWER button once and quickly at 10:00, the air conditioner will turn on at 14:00.

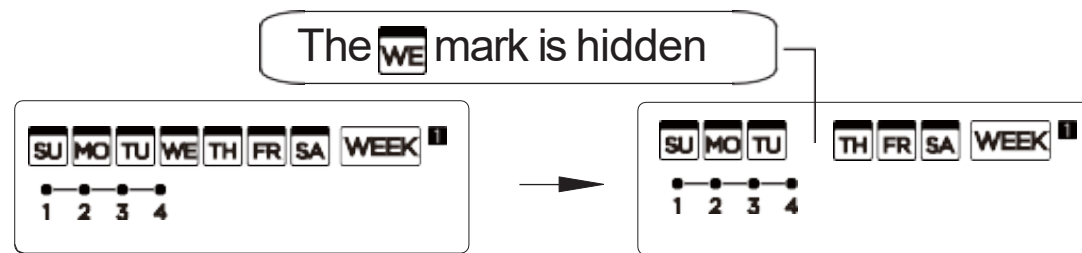
2. When press the Power button for 2 seconds , the air conditioner will turn off completely, at the same time cancel the timing function.

To set the DAY OFF (for a holiday)

1  During the weekly timer, press the Confirm button.

2  Press the button " ^ " or " v " to select the day in this week .

3  Press the Day off button to set the DAY OFF.



ex.The DAY OFF is set for Wednesday

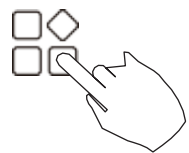
4 The DAY OFF can be setted for other days by repeating the steps 2 and 3.

5  Press the Back button to back to the weekly timer.

To cancel: Follow the same procedures as those for setup.

NOTE : The DAY OFF setting is cancelled automatically after the set day has passed

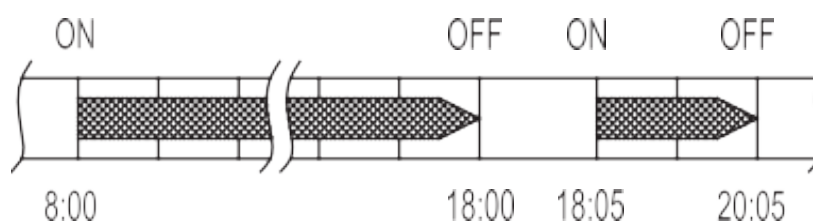
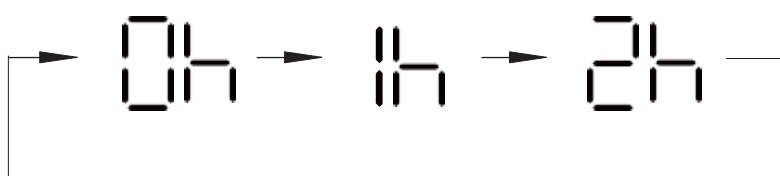
DELAY function



During the weekly timer, press the FUNC. button, select the delay function and press the Confirm button, display “0h” “1h” “2h” and wait 3 seconds to confirm. When the delay function is activated, the “⌚” mark appears.



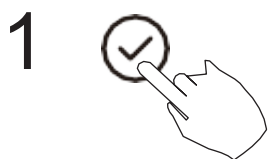
The delay function can only be enabled in Weekly Timer 1 and Weekly Timer 2.



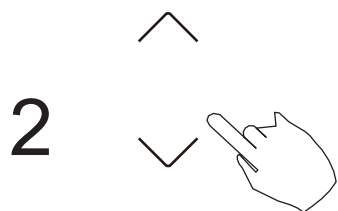
ex. If press select “2h” at 18:05, the air conditioner will delay to turn off at 20:05.

Copy out the setting in one day into the other day.

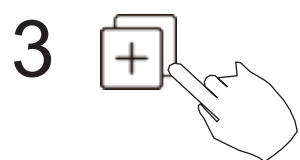
A reservation made once can be copied to another day of the week. The whole reservation of the selected day of the week will be copied. The effective use of the copy mode ensures ease of making reservations.



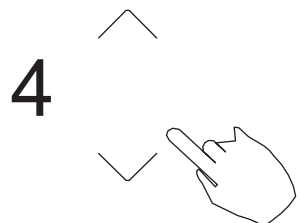
During the weekly timer, press the Confirm button.





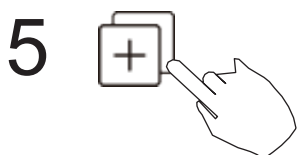
Press the button “^” or “v” to select the day to copy from.



Press the Copy button, the letter “CY” will be shown on the LCD.

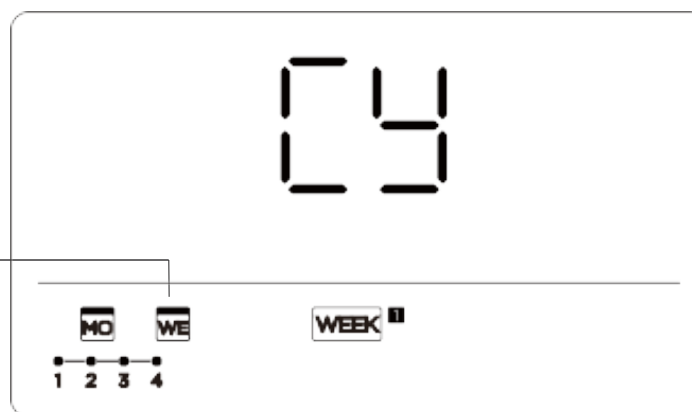


Press the button “” or “” to select the day to copy to.



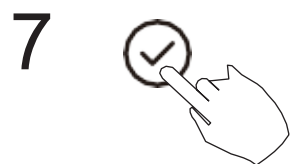
Press the Copy button to confirm .

The  mark flashes quickly

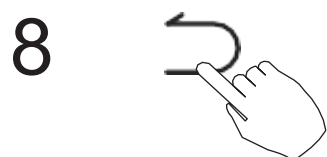


ex. Copy the setting of Monday to Wednesday

6 Other days can be copied by repeating step 4 and 5.



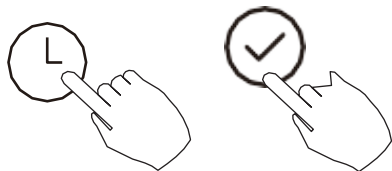
Press the Confirm button to confirm the settings.



Press the Back button to back to the weekly timer.

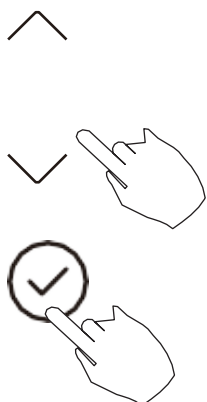
12. Weekly Timer 2

1 Weekly timer setting



Press Timer to select the **WEEK** **2** and press Confirm.

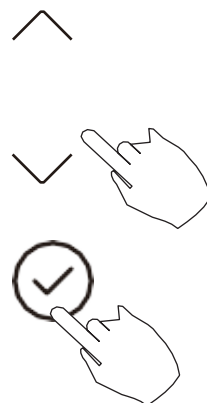
2 Day of the week setting



Press “ \vee ” or “ \wedge ” to select the day of the week and then press CONFIRM.



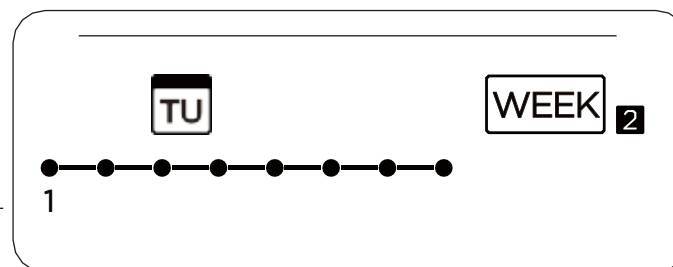
3 ON timer setting of timer setting 1



Press “ \wedge ” or “ \vee ” to select the setting time. The setting time, mode, temperature and fan speed appear on the LCD. Press CONFIRM to enter the setting time process.

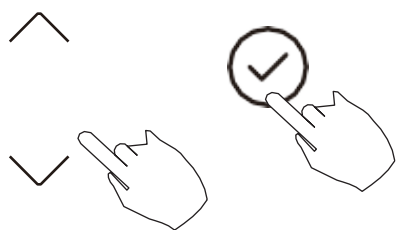
IMPORTANT: Up to 8 scheduled events can be set on one day.

Various events can be scheduled in either MODE, TEMPERATURE and FAN speeds.



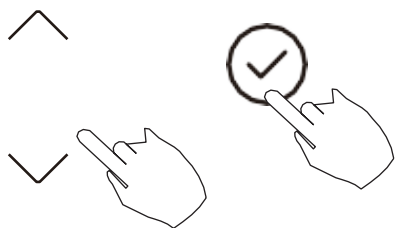
ex. Tuesday time scale 1

4 Time setting

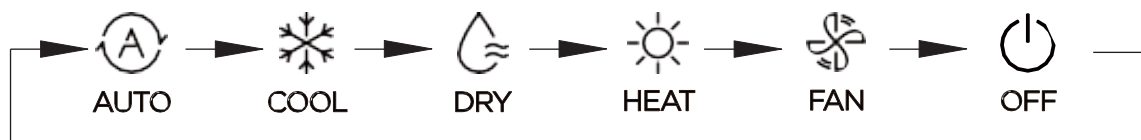


Press “ \wedge ” or “ \vee ” to set the time, then press CONFIRM.

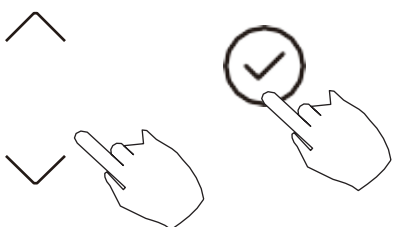
5 Operation mode setting



Press “ \wedge ” or “ \vee ” to set the operation mode then press CONFIRM.



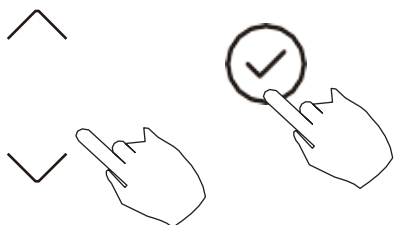
6 Room temperature setting



Press “ \wedge ” or “ \vee ” to set the room temperature, then press CONFIRM.

NOTE : This setting is unavailable in the FAN or OFF modes.

7 Fan speed setting



Press “^” or “v” to set the speed then press CONFIRM.

NOTE : This setting is unavailable in the AUTO, DRY or OFF modes.



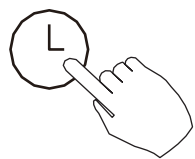
8 Different scheduled events can be set by repeating steps 3 through 7.


9 Additional days, in a one week period, can be set by repeating steps 3 through 8.

NOTE : The weekly timer setting can be returned to the previous step by pressing BACK. The current setting is restored. The controller will not save the weekly timer settings if there is no operation within 30 seconds.

WEEKLY timer operation

To start

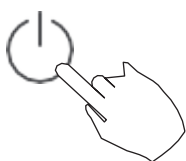


Press Timer to select the **WEEK** , and then the timer starts automatically.

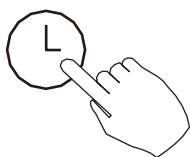


ex.

To cancel



Press the Power buttons for 2 seconds to cancel the timer mode.

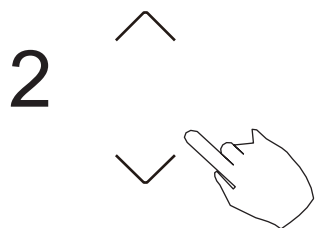


The timer mode can also be canceled by changing the timer mode using Timer.

To set the DAY OFF (for a holiday)

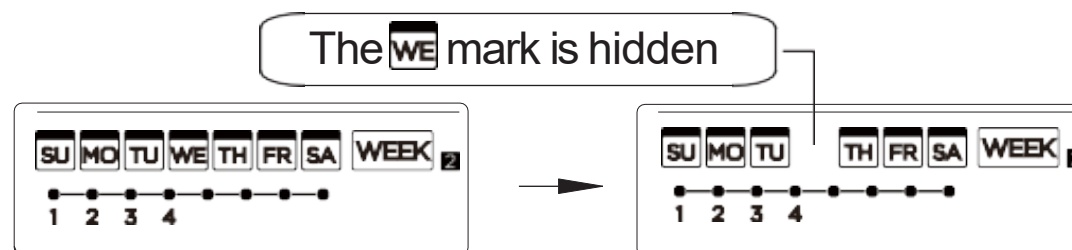
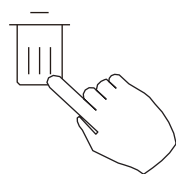


After setting the weekly timer, press CONFIRM.



Press " ^ " or " v " to select the day of the week.

3 Press DAY OFF to create an off day.



ex. The DAY OFF is set for Wednesday

4 Set the DAY OFF for other days by repeating the steps 2 and 3.

5 Press BACK to revert to the weekly timer.



To cancel, follow the same procedures used for setup.


NOTE : The DAY OFF setting is cancelled automatically after the set day has passed.


Copy out the setting in one day into the other day.

A scheduled event, made once, can be copied to another day of the week. The scheduled events of the selected day of the week will be copied. The effective use of the copy mode ensures the ease of reservation making.

1 In the weekly timer, press CONFIRM.

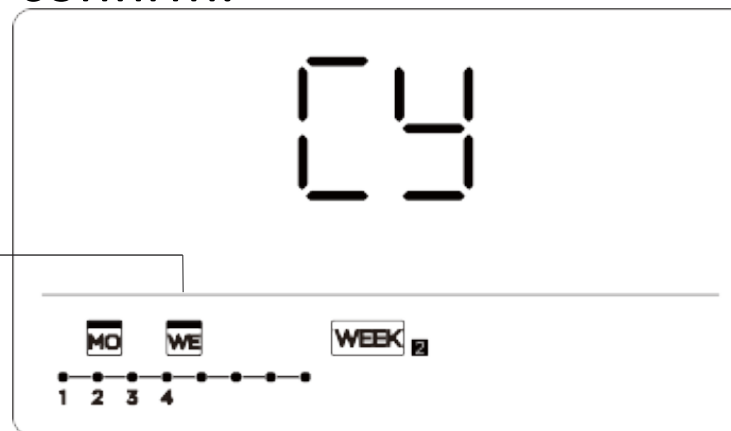


2  Press " ^ " or " v " to select the day to copy from.

3  Press COPY, the letters CY appear on the LCD.

4  Press " ^ " or " v " to select the day to copy to.

5  Press COPY to confirm.

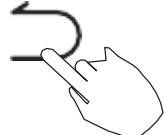


The **WE** mark flashes quickly

ex. Copy the setting of Monday to Wednesday

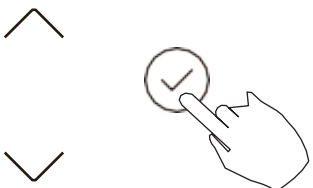
6 Other days can be copied by repeating steps 4 and 5.

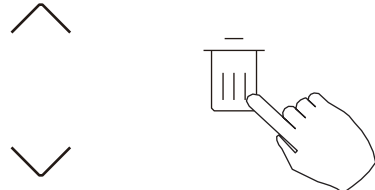
7  Press CONFIRM to confirm the settings.

8  Press BACK to revert to the weekly timer.

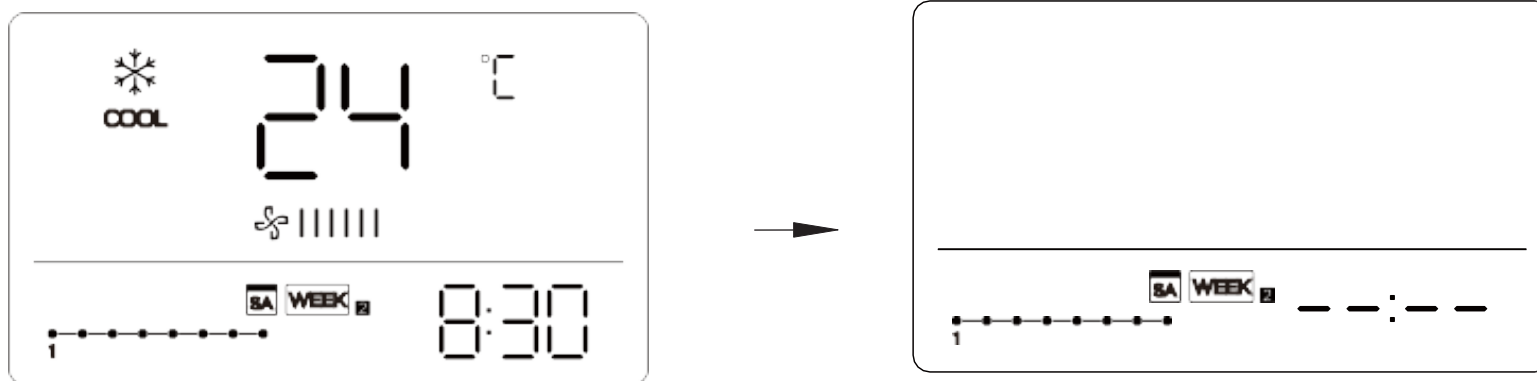
Delete the time scale in one day.

1  During the weekly timer setting, press CONFIRM.

2  Press “^” or “v” to select the day of the week and then press CONFIRM.

3 

Press “^” or “v” to select the setting time want to delete. The setting time, mode, temperature and fan speed appear on the LCD. The setting time, mode, temperature and fan speed can be deleted by pressing the DEL (day off).



ex. Delet the time scale I in saturday

13. Fault alarm handing

If the system does not properly operate except the above mentioned cases or the above mentioned malfunctions is evident, investigate the system according to the following procedures.

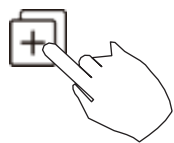
NO.	MALFU N C T I O N & P R O T E C T I O N D E F I N E	D I S P L A Y D I G I T A L T U B E
1	Error of communication between wire controler and indoor unit	EH63

The error displayed on the wire controller are different from those on the unit. If error code appears, please check the <<Owner' s And Installation Manual>>and<<SERVICE Manual>>.

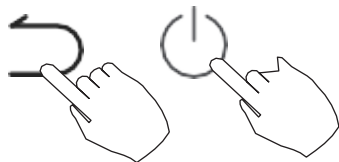
14. Technical indication and requirement

EMC and EMI comply with the CE certification requirements.

15. Queries and settings



When the air conditioning unit is switch machine, Long press “COPY” for 3 seconds , first display P:00, if connected to an indoor unit, display P:00, if connected to multiple indoor units, press “^” or “v” to display P:01, P:02, and then press “Confirm” to enter the query indoor unit Tn(T1~T4) temperature and fan fault(CF), press “^” or “v” to select.



Not operating keys 15 seconds or press “Back” or press “ON/OFF” drop out of query temperature.



When the air conditioning unit is off, into the query function of temperature, press “^” or “v” to select SP, press “Confirm” to adjust the static pressure value.



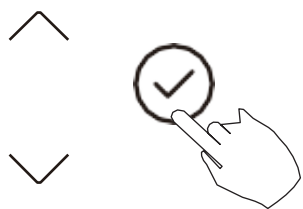
When the air conditioning unit is off, into the query function of temperature, press “^” or “v” to select AF, press “Confirm” into test mode, press “Back” or press “ON/OFF” or press “Confirm” drop out of test mode. In AF mode, 3~6 minutes test completion automatically exits, if the test process, press “Back” or press “ON/OFF” or press “Confirm” , the test exits will be interrupted.



Follow me function temperature compensation

When the air conditioning unit is off, into the query function of temperature, press “^” or “v” to select tF.

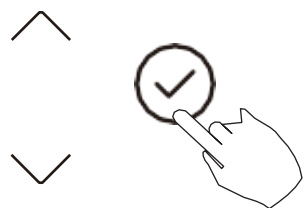
The compensation temperature Range : -5~5°C.



tF

Press “Confirm” into setting state, press “^” or “v” to select the temperature, then press “Confirm” to complete it.

tF : compensation temperature



When the air conditioning unit is off, into the query function of temperature, press “^” or “v” to select tyPE. Press “Confirm” into setting state, press “^” or “v” to select the type, then press “Confirm” to complete it.

tyPE

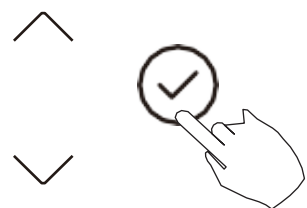
CH:     
AUTO COOL DRY HEAT FAN

HH:  
HEAT FAN

CC:   
COOL DRY FAN

NA:    
COOL DRY HEAT FAN

Set the highest and lowest temperature values



When the air conditioning unit is off, into the query function of temperature, press “ \wedge ” or “ \vee ” to select tHl or tLo.

Press “Confirm” into setting state, press “ \wedge ” or “ \vee ” to select the temperature, then press “Confirm” to complete it.

The highest setting temperature range : 25~30°C

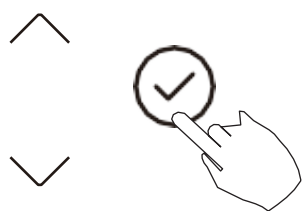
The lowest setting temperature range: 17 ~24°C.



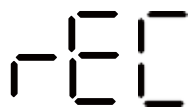
tHl : Highest value setting function.

tLo : Minimum value setting function.

Remote control function selection of wire controller



When the air conditioning unit is off, into the query function of temperature, press “ \wedge ” or “ \vee ” to select rEC. ON or OF will be displayed in the temperature area to indicate whether it is valid or invalid.

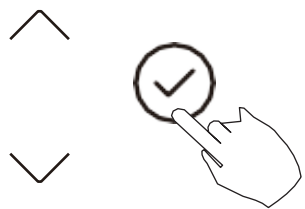


When the selection is invalid, the wire controller does not process any remote control signals.

Press “Confirm” into setting state, press “ \wedge ” or “ \vee ” to select , then press “Confirm” to complete it.

Two - line controller address selection

When the air conditioning unit is off, into the query function of temperature, press “ \wedge ” or “ \vee ” to select Adr, the temperature zone will display -- or A, B. Where -- refers to the code setting of the wire controller.



Press “Confirm” into setting state, press “ \wedge ” or “ \vee ” to select , then press “Confirm” to complete it.

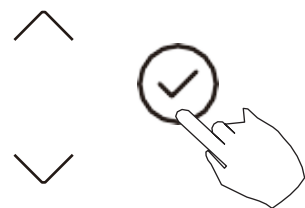
Adr

-- : The code setting  of the wire controller shall prevail.

Adr -- : The wire controller address setting.

Restore factory Settings

When the air conditioning unit is off, into the query function of temperature, press “ \wedge ” or “ \vee ” to select INIt, the temperature zone displayed --.



Press “Confirm” into setting state, press “ \wedge ” or “ \vee ” to select to "ON" , then press “Confirm” to complete it.

INIt

INIt : Restore factory Settings .

After the wire controller resumes the factory parameter setting, the rotating parameter setting is restored to 10 hours (the highest and lowest temperature are not set); The compensation of body temperature is uncompensated; COOL and HEAT/single COOL mode is restored to COOL and HEAT model;

Restore the temperature range to the factory setting. Remote receiving function is restored to be effective;

The address of the two-control first-line controller is restored to the code switch.

16. Wireless control connection

SAFETY PRECAUTION

- Read the safety precautions carefully before installing the unit.
- Stated below are important safety issues that must be obeyed.
Applicable system: IOS, Android. (Suggest: IOS 9.0 and above, Android 6.0 and above.)

NOTE :

- Due to special situation may be occurred, we explicitly claim below: Not all of the Android and IOS systems are compatible with APP. We will not be responsible for any issues as a result of the incompatibility.

Wireless safety strategy

- Smart kit only support WPA-PSK/WPA2-PSK encryption and none encryption . WPA-PSK/WPA2-PSK encryption is recommended.

CAUTION

- Please Check The Service Website For More Information.
- Smart Phone camera needs to be 5 million pixels or above to make sure scan QR code well.
- Due to different network situation, sometimes, request time-out could happen, thus, it is necessary to do network configuration again.
- Due to different network situation, control process may return time-out sometimes. If this situation occurs, the display between board and App may not be the same, please do not feel confused.

NOTE :

Company will not be liable for any issues and problems caused by Internet, Wi-Fi Router and Smart Devices.

Please contact the original provider to get further help.

DOWNLOAD AND INSTALL APP

On an app market (Google Play Store, Apple App Store), search for "Ecoer Home Plus" and find the Ecoer Home Plus app. Download and install it on your phone.

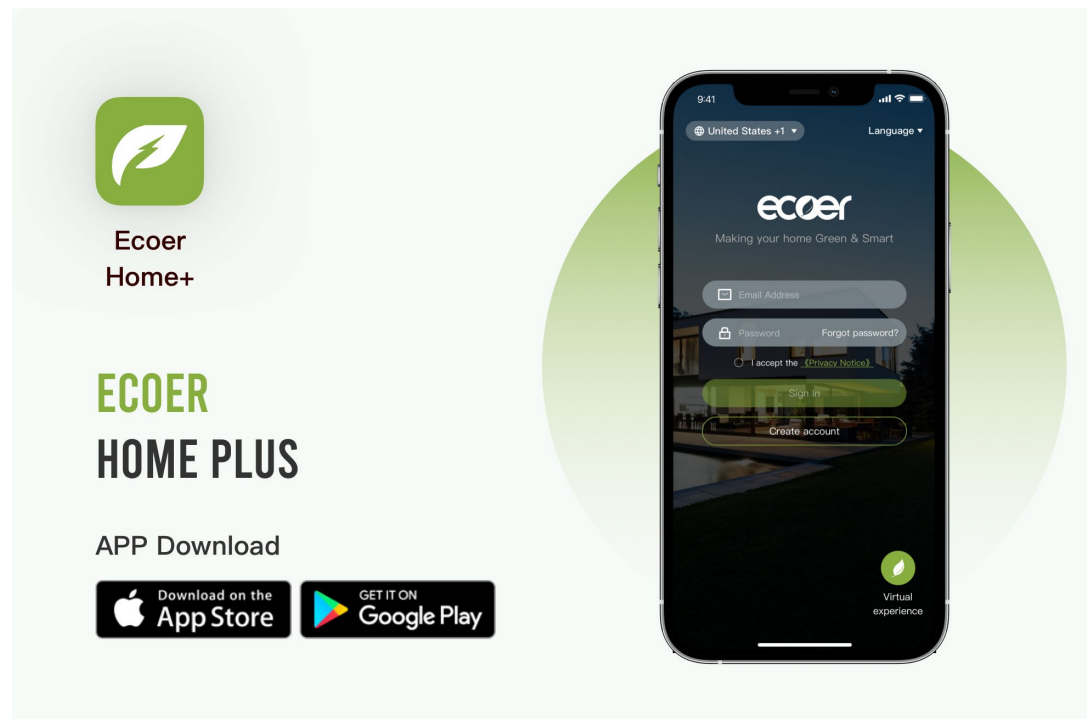


Fig.16 -1

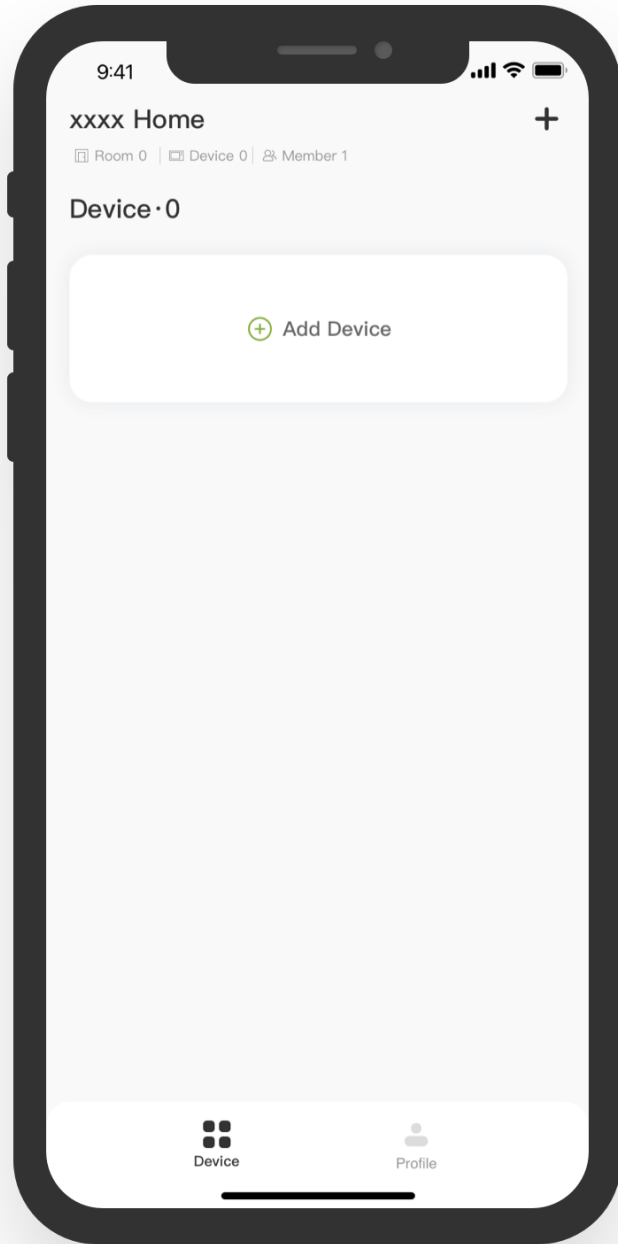
- Please ensure your mobile device is connected to Wireless Network router. Also, the Wireless Network router has already connected to Internet before doing user registration and network configuration.
- Make sure your mobile device has already been connected to the Wireless Network which you want to use. Also, you need to forget other irrelative Wireless Network in case it influences your configuration process.

Network configuration by Ecoer Home Plus App

*The design of Ecoer Home Plus App may subject to change. You can download the the newest guide by scanning the QR code below.

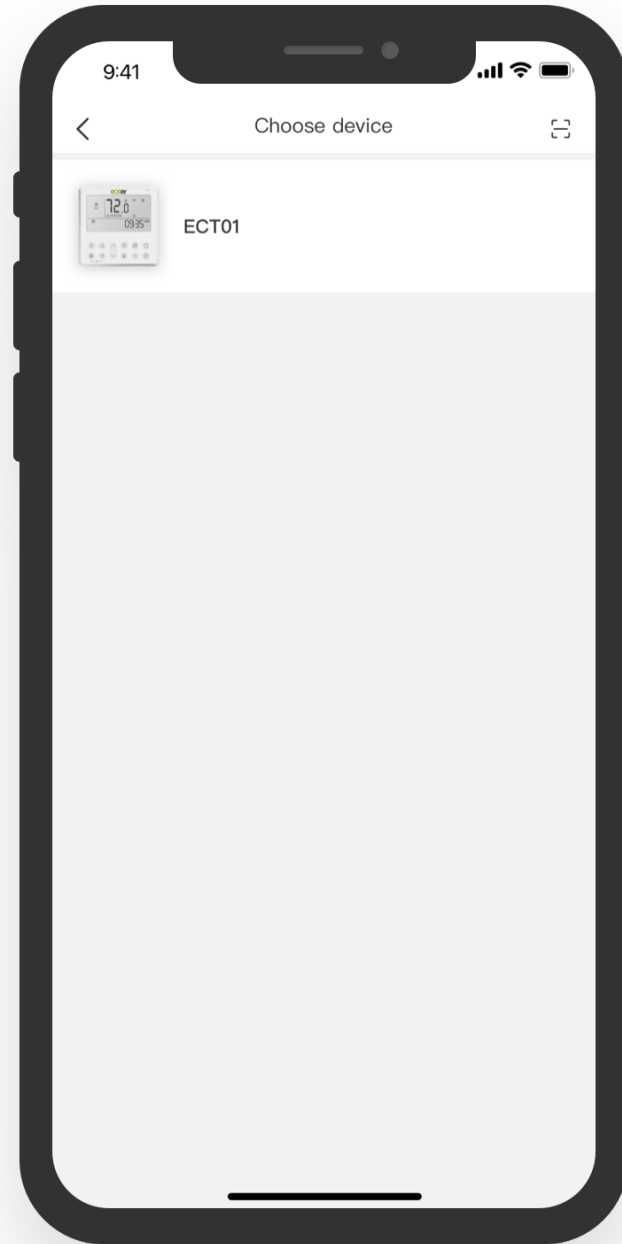


Fig.16 - 2



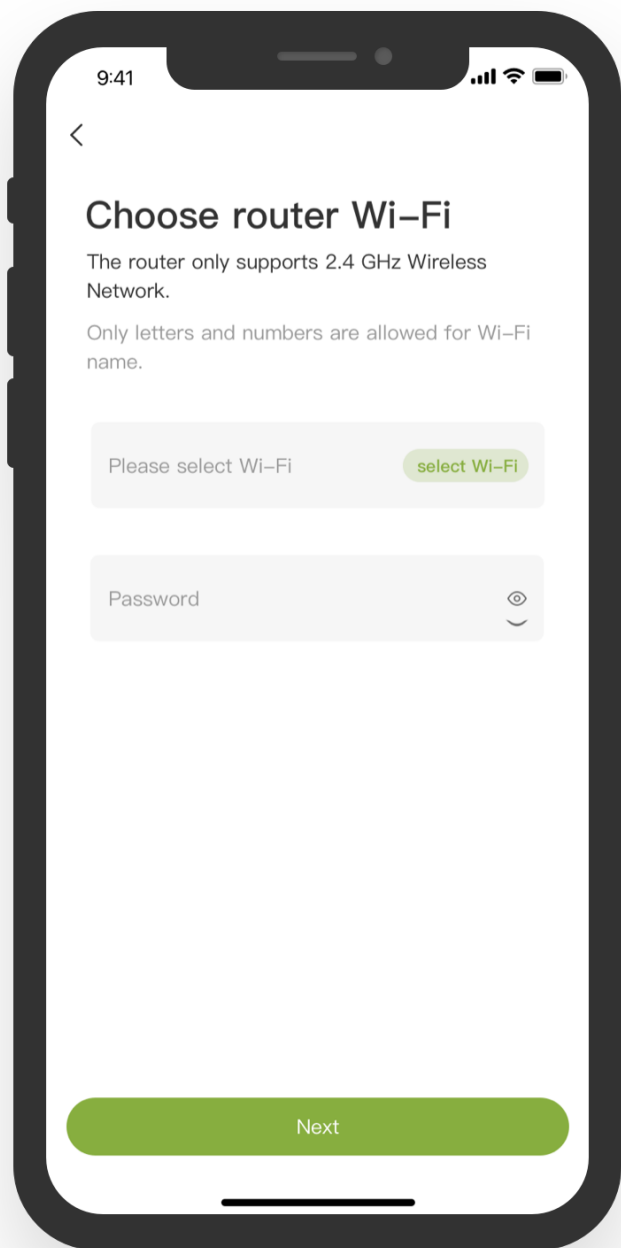
① Press “ + Add Device ”

Fig.16 - 3



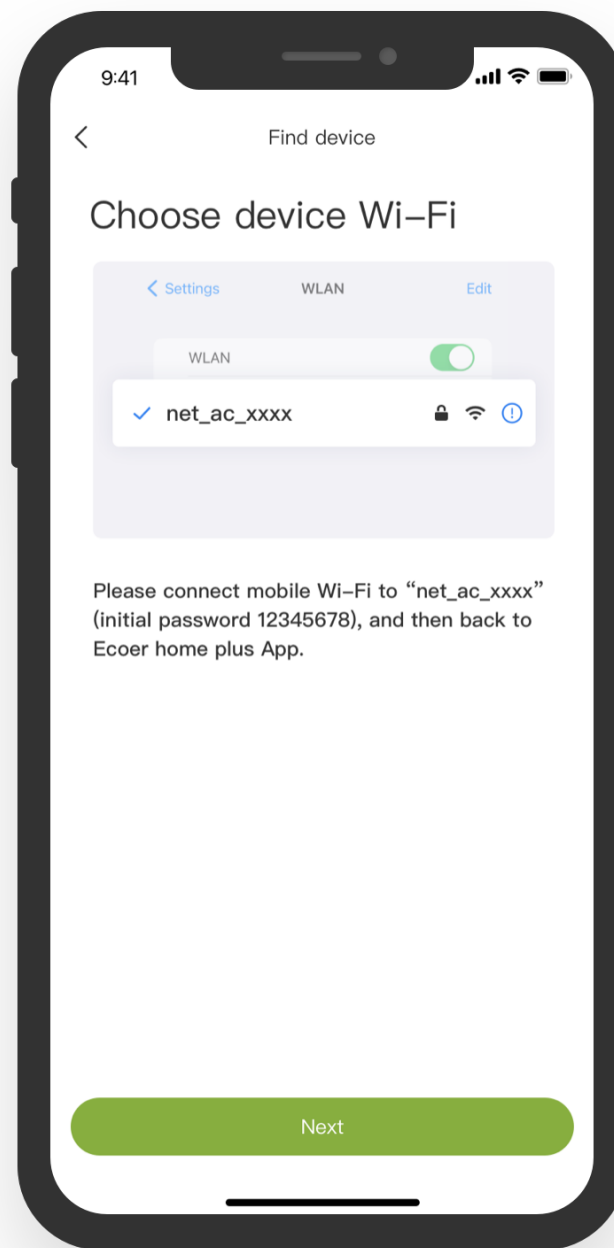
② Choose device type

Fig.16 - 4



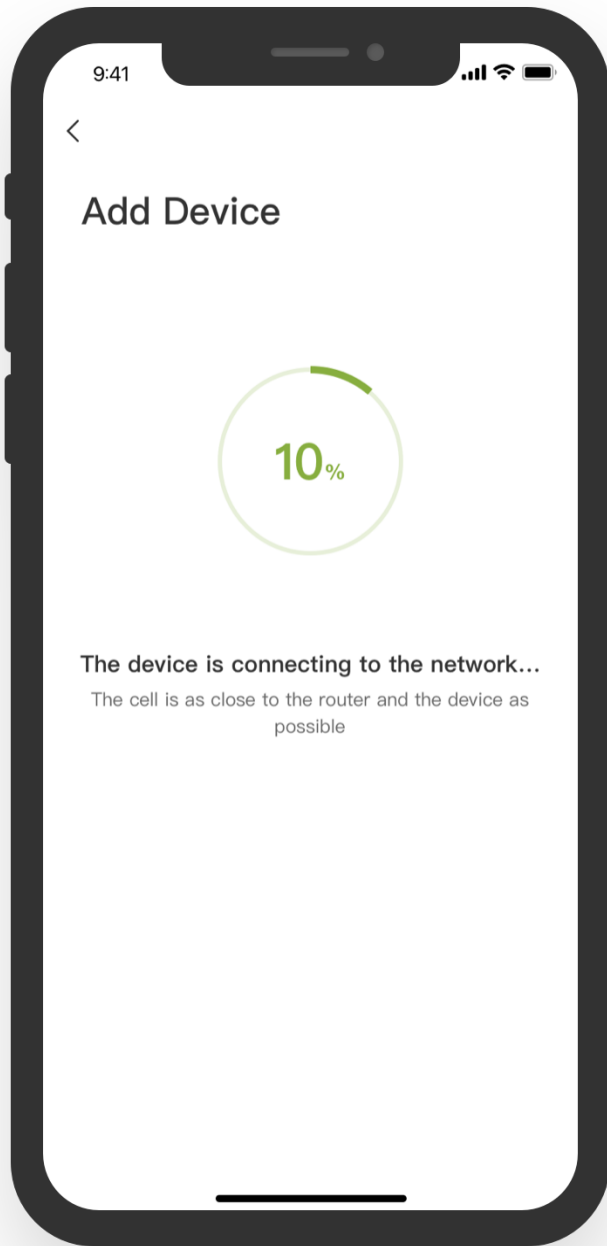
③ Select home Wi-Fi, enter the password

Fig.16 - 5



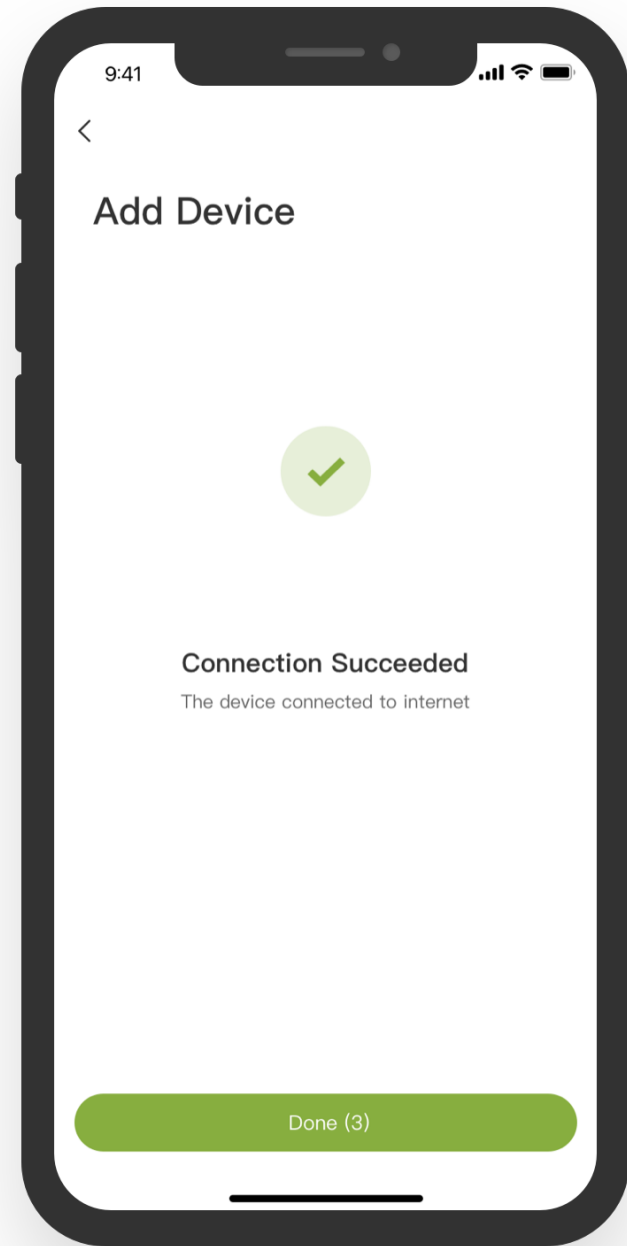
④ Connect to Device Wi-Fi

Fig.16 - 6



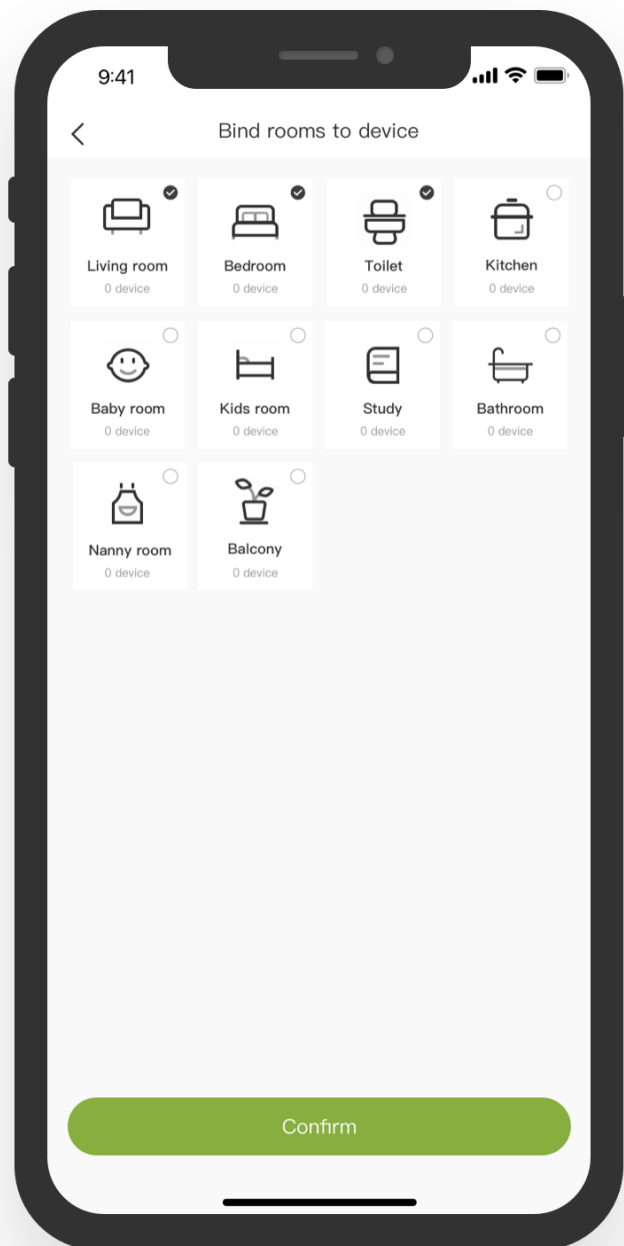
⑤ Wait connecting to the network

Fig.16 - 7



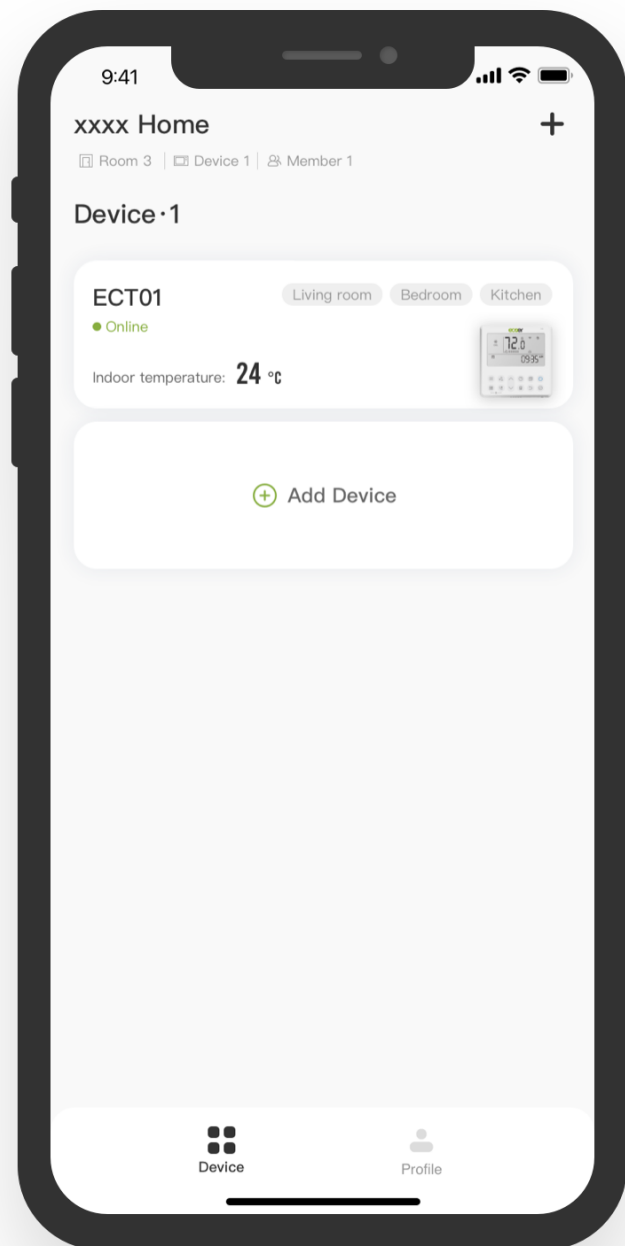
⑥ Configuration Success

Fig.16 - 8



⑦ You can bind rooms to device

Fig.16 - 9



⑧ The network configuration is successful, now you can see the device in the list

Fig.16 - 10

NOTE

- Make sure your devices are powered on.
- Keep your mobile phone close enough to your device when you are connecting network to your device.
- Connect your mobile phone to the wireless network at home, and make sure you know the password of the Wireless Network.
- Check if your router supports 2.4 GHz Wireless Network band and turn it on. If you are not sure whether the router supports 2.4 GHz band, please contact the router manufacturer.
- The device cannot connect to the Wireless Network that requires authentication, and it usually appears in public area such as hotels, restaurants, etc. Please connect to a Wi-Fi that does not require authentication.
- It is recommended to use a Wireless Network name that only contains letters and numbers. If your Wireless Network name contains special characters, please modify it in the router.
- Turn off the WLAN+ (Android) or WLAN Assistant (iOS) function of your mobile phone when connecting network to your devices.
- In the case that your device connected to Wireless Network before but it needs to reconnect, please click "+" on app Home page, and add your device again by the device category and model according to the instructions on app.

APP DECLARATION

Hereby, we declare that this Smart kit is in compliance with the essential requirements and other relevant provisions of Directive 2014/53/EU. A copy of the full DoC is attached.(European Union products only)

CAUTION

Wireless Network module models: US-SK107, EU-SK107:
FCC ID: 2ADQOMDNA21 IC: 12575A-MDNA21

This device complies with Part 15 of the FCC Rules and it contains licence-exempt transmitter(s)/receiver(s) that comply with Innovation, Science and Economic Development Canada's licence-exempt RSS(s). Operation is subject to the following two conditions:

- (1) This device may not cause interference; and
- (2) This device must accept any interference, including interference that may cause undesired operation of the device.

Only operate the device in accordance with the instructions supplied.

Changes or modifications to this unit not expressly approved by the party responsible for compliance could void the user's authority to operate the equipment.

This device complies with FCC radiation exposure limits set forth for an uncontrolled environment. In order to avoid the possibility of exceeding the FCC radio frequency exposure limits, human proximity to the antenna shall not be less than 20cm (8 inches) during normal operation.

NOTE

This equipment has been tested and found to comply with the limits for a Class B digital device, pursuant to part 15 of the FCC Rules.

These limits are designed to provide reasonable protection against harmful interference in a residential installation. This equipment generates, uses and can radiate radio frequency energy and, if not installed and used in accordance with the instructions, may cause harmful interference to radio communications. However, there is no guarantee that interference will not occur in a particular installation. If this equipment does cause harmful interference to radio or television reception, which can be determined by turning the equipment off and on, the user is encouraged to try to correct the interference by one or more of the following measures:

- Reorient or relocate the receiving antenna.
- Increase the separation between the equipment and receiver.
- Connect the equipment into an outlet on a circuit different from that to which the receiver is connected.
- Consult the dealer or an experienced radio/TV technician for help.

©2022 ECOER INC.

43671 Trade Center Place, Suite 100
Dulles, VA 20166

Tel: 703-348-2538

www.ecoer.com